

# paco jaanson

## BATHROOM CARE

1000mm Solid Surface Resin Washbasin - Gloss White

Code: WBM-1002-1



Featured with Benelli Freedom Care Mixer 38119 ( Sold Separately )

### Dimensions

1000mm (w) x 555mm (d) x 128mm (h)

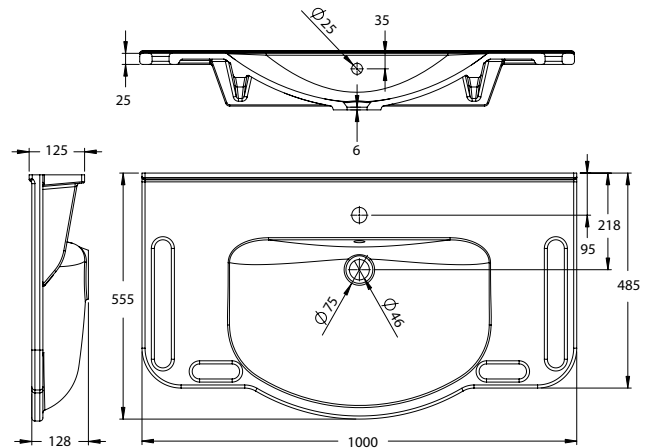

All measurements are in millimetres & subject to change without notice.



## DESCRIPTION

The Paco Jaanson Care range is committed to providing innovative solutions formed through knowledge and insight to ensure critical living hubs like bathrooms are designed to fully consider the needs of users and their carer's, to maximise independence and a greater degree of user comfort, dignity, respect and safety.

Their aged care and disability solutions are adaptable and allow flexibility when renovations or redesign is being considered. Benelli puts the user first so you can choose Paco Jaanson with confidence.

### Features

- Integrated handles and towel bars
- One tap hole\* ( No tap hole optional )
- Plug and waste not included
- 5 Years Limited Manufacturers Warranty
- 1 Year Limited Commercial Warranty
- ♿ Suitable for installation to comply to Australian Standard AS 1428.1-2009 Design for access and mobility
- No overflow ( overflow optional )

\*Additional holes - Optional extra.

## PRICING STRUCTURE

Retail Pricing:  
WBM-1002-1  
\$1,420.00 ex.gst

PACO JAANSON BATHROOM INNOVATIONS  
Copyright © 2018. All rights reserved. Updated: 02nd May 2021.

Telephone : 1800 006 260  
Email - info@pacojaanson.com.au  
www.pacojaanson.com.au

# paco jaanson

## BATHROOM CARE

1000mm Solid Surface Resin Washbasin - Gloss White  
Code: WBM-1002-1



## ACCESS AND MOBILITY

Suitable for installation to comply to Australian Standard AS 1428.1-2009 Design for access and mobility

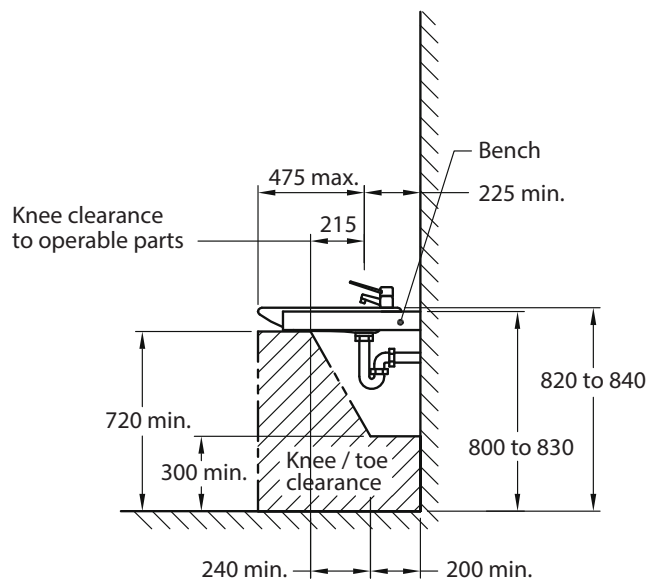
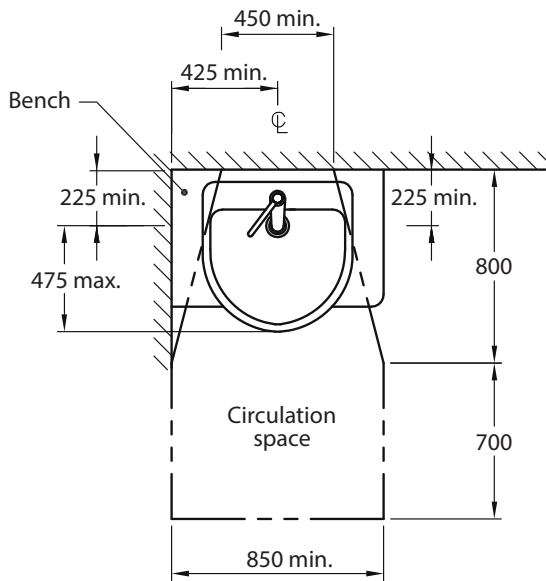

DIMENSIONS IN MILLIMETRES

WASHBASIN FOR ACCESSIBLE SOLE - OCCUPANCY UNIT

[www.standards.org.au](http://www.standards.org.au)



All installations should be carried out by a qualified tradesman in compliance with the national Plumbing & Drainage Code and any State or Local Authority Regulations, in accordance with AS/NZS 3500 series of standards and AS/NZA 6400.

## WARRANTY STATEMENT

This Paco Jaanson washbasin is guaranteed for 5 years from date of purchase subject to the following conditions:

1. Installation has been carried out by a licensed plumber in accordance with the plumbing code of Australia.
2. All maintenance and adjustments to the product after the installation have been carried out by a licensed plumber.
3. Only mild household detergents and soft (non-abrasive) cloth has been used to clean the product.
4. All goods of substandard quality manufacture (excluding imperfections permitted within AS1976 - solid surface resin used in sanitary applications) will be credited or replaced by Paco Jaanson when advised within the warranty period, subject to prior inspection and agreement.
5. Proof of purchase is required for warranty claims.

FULL WARRANTY & CONDITIONS

[www.pacojaanson.com.au](http://www.pacojaanson.com.au)

## LIMITATIONS

To the extent permitted under the Trade Practices Act and other relevant legislation, Paco Jaanson's liability is limited to: The cost of replacing the goods, or The cost of obtaining equivalent goods, or The cost of having the goods repaired. Paco Jaanson is not responsible for any lack of operation or performance of goods (or any loss or damage) where goods are used or adapted for a with other goods not supplied by Paco Jaanson. It is the responsibility of the customer and installer before installation to ensure are correct and free of obvious visible faults. Paco Jaanson is not responsible for the labour and rectification costs incurred in the above circumstance.

## PRICING STRUCTURE

Retail Pricing:  
WBM-1002-1  
\$1,420.00 ex.gst

PACO JAANSON BATHROOM INNOVATIONS  
Copyright © 2018. All rights reserved. Updated: 02nd May 2021.

Telephone : 1800 006 260  
Email - [info@pacojaanson.com.au](mailto:info@pacojaanson.com.au)  
[www.pacojaanson.com.au](http://www.pacojaanson.com.au)